

## ISO PUMP UNIT BASE KITS

### SOUTHERN CROSS ISO PUMP UNIT BASE KITS



**BASE KIT INCLUDES:-**

- GALVANISED PRESSED STEEL BASEPLATE (NOT DRILLED)
- FLEXIBLE COUPLING
- GALVANISED COUPLING GUARD
- SHIMS FOR ON SITE ALIGNMENT
- SPACERS & FASTENERS FOR PUMP & MOTOR

**NOTE:-**

PRICES **DO NOT** INCLUDE ASSEMBLY OF UNITS. FOR COMPLETE UNITS REFER TO PES SECTION.

**DISCOUNT CATEGORY A9**

MODEL PUMP MOTOR	BASE KIT (INCLUDING COUPLING)			
	STANDARD		SPACER	
	CODE	PRICE \$	CODE	PRICE \$
<b>50 X 32 - 160</b>	<b>PSEA1C</b>			
0.55 KW 4 POLE	PB001	668	PB002	745
0.75 KW 4 POLE	PB001	668	PB002	745
3.0 KW 2 POLE	PB005	668	PB006	745
4.0 KW 2 POLE	PB007	668	PB008	745
5.5 KW 2 POLE	PB009	754	PB010	868
<b>50 X 32 - 200</b>	<b>PSFA1C</b>			
0.55 KW 4 POLE	PB153	668	PB154	745
0.75 KW 4 POLE	PB153	668	PB154	745
1.1 KW 4 POLE	PB156	668	PB159	745
1.5 KW 4 POLE	PB157	668	PB160	745
5.5 KW 2 POLE	PB161	797	PB162	868
7.5 KW 2 POLE	PB161	797	PB162	868
11.0 KW 2 POLE	PB164	797	PB165	868
<b>65 X 50 - 160</b>	<b>PSEB1C</b>			
0.55 KW 4 POLE	PB001	668	PB002	745
0.75 KW 4 POLE	PB001	668	PB002	745
1.1 KW 4 POLE	PB151	668	PB152	745
4 KW 2 POLE	PB007	668	PB008	745
5.5 KW 2 POLE	PB009	754	PB010	868
7.5 KW 2 POLE	PB009	754	PB010	868
<b>65 X 40 - 200</b>	<b>PSFB1C</b>			
1.1 KW 4 POLE	PB013	668	PB014	745
1.5 KW 4 POLE	PB155	668	PB158	745
2.2 KW 4 POLE	PB029	668	PB030	745
7.5 KW 2 POLE	PB015	890	PB016	981
11 KW 2 POLE	PB017	890	PB018	981
15 KW 2 POLE	PB024	965	PB031	1052



**ISO PUMP UNIT BASE KITS**

**SOUTHERN CROSS ISO PUMP UNIT BASE KITS (Cont'd)**

**DISCOUNT CATEGORY A9**

MODEL PUMP MOTOR	BASE KIT (INCLUDING COUPLING)			
	STANDARD		SPACER	
	CODE	PRICE \$	CODE	PRICE \$
<b>65 X 40 - 250</b>	<b>PSGB2C</b>			
1.5 KW 4 POLE	PB062	668	PB063	745
2.2 KW 4 POLE	PB034	668	PB035	850
3.0 KW 4 POLE	PB064	754	PB035	850
11 KW 2 POLE	PB040	890	PB065	900
15 KW 2 POLE	PB040	890	PB041	990
18.5 KW 2 POLE	PB177	890	PB042	990
22 KW 2 POLE	PB043	903	PB044	998
30 KW 2 POLE	PB045	903	PB046	998
<b>65 X 40 - 315</b>	<b>PSHB2C</b>			
3 KW 4 POLE	PB134	668	PB127	745
4 KW 4 POLE	PB135	668	PB128	868
5.5 KW 4 POLE	PB129	754	PB130	868
22 KW 2POLE	PB136	833	PB131	1019
30 KW 2 POLE	PB132	833	PB133	1019
37 KW 2 POLE	PB132	833	PB133	1019
45 KW 2 POLE	PB094	833	PB095	1019
<b>80 X 65 - 160</b>	<b>PSEC1C</b>			
0.75 KW 4 POLE	PB011	668	PB012	745
1.1 KW 4 POLE	PB013	668	PB014	745
1.5 KW 4 POLE	PB155	668	PB158	745
5.5 KW 2 POLE	PB015	890	PB016	981
7.5 KW 2 POLE	PB015	890	PB016	981
11 KW 2 POLE	PB017	890	PB018	981
15 KW 2 POLE	PB024	965	PB025	1052
<b>80 X 50 - 200</b>	<b>PSFC1C</b>			
1.5 KW 4 POLE	PB155	668	PB158	745
2.2 KW 4 POLE	PB029	668	PB030	745
3 KW 4 POLE	PB029	668	PB030	745
11 KW 2 POLE	PB017	890	PB018	981
15 KW 2 POLE	PB024	965	PB031	1052
18.5 KW 2 POLE	PB170	965	PB172	1052
22 KW 2 POLE	PB032	965	PB033	1052
<b>80 X 50 - 250</b>	<b>PSGC2C</b>			
3 KW 4 POLE	PB034	668	PB035	850
4 KW 4 POLE	PB036	754	PB037	868
5.5 KW 4 POLE	PB038	754	PB039	868
22 KW 2 POLE	PB043	903	PB044	998
30 KW 2 POLE	PB045	903	PB046	998
37 KW 2 POLE	PB045	903	PB046	998
45 KW 2 POLE	PB143	1099	PB144	1135
<b>80 X 50 - 315</b>	<b>PSHC2C</b>			
4 KW 4 POLE	PB098	861	PB099	909
5.5 KW 4 POLE	PB137	861	PB100	909
7.5 KW 4 POLE	PB181	861	PB138	909
30 KW 2 POLE	PB103	898	PB104	995
37 KW 2 POLE	PB103	898	PB104	995
45 KW 2 POLE	PB105	948	PB139	1041
55 KW 2 POLE	PB106	1113	PB107	1616
75 KW 2 POLE	PB191	1166	PB192	1616

## ISO PUMP UNIT BASE KITS

### SOUTHERN CROSS ISO PUMP UNIT BASE KITS (Cont'd)

STANDARD  
BASE KIT



SPACER  
BASE KIT



**BASE KIT INCLUDES:-**

- GALVANISED PRESSED STEEL BASEPLATE (NOT DRILLED)
- FLEXIBLE COUPLING
- GALVANISED COUPLING GUARD
- SHIMS FOR ON SITE ALIGNMENT
- SPACERS & FASTENERS FOR PUMP & MOTOR

**NOTE:-**

PRICES DO NOT INCLUDE ASSEMBLY OF UNITS.  
FOR COMPLETE UNITS REFER TO PES SECTION.

DISCOUNT CATEGORY A9

MODEL PUMP MOTOR	BASE KIT (INCLUDING COUPLING)			
	STANDARD		SPACER	
	CODE	PRICE \$	CODE	PRICE \$
<b>100 X 80 - 160</b>	<b>PSD2C</b>			
1.1 KW 4 POLE	PB019	668	PB020	745
1.5 KW 4 POLE	PB166	668	PB167	745
2.2 KW 4 POLE	PB021	668	PB022	745
3 KW 4 POLE	PB175	668	PB176	745
11 KW 2 POLE	PB163	856	PB023	895
15 KW 2 POLE	PB168	940	PB171	984
18.5 KW 2 POLE	PB169	955	PB026	1034
<b>100 X 65 - 200</b>	<b>PSFD2C</b>			
2.2 KW 4 POLE	PB034	668	PB035A	833
3 KW 4 POLE	PB034	668	PB035A	833
4 KW 4 POLE	PB036	754	PB037A	1009
5.5 KW 4 POLE	PB038	754	PB039A	1009
18.5 KW 2 POLE	PB177	890	PB042A	920
22 KW 2 POLE	PB043	903	PB044A	981
30 KW 2 POLE	PB045	903	PB046A	981
37 KW 2 POLE	PB045	903	PB046A	981
<b>100 X 65 - 250</b>	<b>PSGD2C</b>			
4 KW 4 POLE	PB067	812	PB050	883
5.5 KW 4 POLE	PB051	812	PB052	883
7.5 KW 4 POLE	PB178	812	PB053	883
30 KW 2 POLE	PB056	955	PB057	1071
37 KW 2 POLE	PB056	955	PB057	1071
45 KW 2 POLE	PB069	1286	PB070	1765
55 KW 2 POLE	PB071	1346	PB072	1852
75 KW 2 POLE	PB060	1438	PB061	1852
<b>100 X 65 - 315</b>	<b>PSHD3C</b>			
7.5 KW 4 POLE	PB182	826	PB183	1027
11 KW 4 POLE	PB075	955	PB076	1071
15 KW 4 POLE	PB077	955	PB184	1071
55 KW 2 POLE	PB080	1101	PB081	1852
75 KW 2 POLE	PB185	1113	PB186	2440
90 KW 2 POLE	PB082	1737	PB083	2440
110 KW 2 POLE	PB187	2024	PB188	2440



**ISO PUMP UNIT BASE KITS**

**SOUTHERN CROSS ISO PUMP UNIT BASE KITS (Cont'd)**

DISCOUNT CATEGORY A9

MODEL PUMP MOTOR	BASE KIT (INCLUDING COUPLING)			
	STANDARD		SPACER	
	CODE	PRICE \$	CODE	PRICE \$
<b>125 X 80 - 200</b>	<b>PSFE2C</b>			
2.2 KW 4 POLE	PB034	668	PB035A	833
3.0 KW 4 POLE	PB034	668	PB035A	833
4.0 KW 4 POLE	PB036	754	PB037A	1009
5.5 KW 4 POLE	PB038	754	PB039A	1009
7.5 KW 4 POLE	PB038	754	PB039A	1009
18.5 KW 2 POLE	PB177	890	PB042A	920
22 KW 2 POLE	PB043	903	PB044A	981
30 KW 2 POLE	PB045	903	PB046A	981
37 KW 2 POLE	PB045	903	PB046A	981
45 KW 2 POLE	PB143	1099	PB144A	1250
<b>125 X 80 - 250</b>	<b>PSGE2C</b>			
4.0 KW 4 POLE	PB098	861	PB099S	825
5.5 KW 4 POLE	PB137	861	PB100	909
7.5 KW 4 POLE	PB181	861	PB100	909
11 KW 4 POLE	PB221	867	PB222	972
30 KW 2 POLE	PB103B	867	PB103S	972
37 KW 2 POLE	PB103B	867	PB103S	972
45 KW 2 POLE	PB105B	946	PB105S	1205
55 KW 2 POLE	PB106B	1113	PB106S	1469
75 KW 2 POLE	PB191B	1231	PB191S	1969
90 KW 2 POLE	PB223	1772	PB244	1964
<b>125 X 80 - 315</b>	<b>PSHE3C</b>			
7.5 KW 4 POLE	PB084	815	PB085	946
11 KW 4 POLE	PB088	955	PB189	1071
15 KW 4 POLE	PB088	955	PB189	1071
18.5 KW 4 POLE	PB190	955	PB091	1071
55 KW 2 POLE	PB225	1012	PB226	1684
75 KW 2 POLE	PB108	1949	PB109	2440
90 KW 2 POLE	PB193	1949	PB194	2440
110 KW 2 POLE	PB193	1949	PB194	2440
132 KW 2 POLE	PB193	1949	PB194	2440
<b>125 X 80 - 400</b>	<b>PSJE3C</b>			
11 KW 4 POLE	PB196	955	PB199	1071
15 KW 4 POLE	PB119	955	PB120	1071
18.5 KW 4 POLE	PB121	955	PB140	1071
22 KW 4 POLE	PB202	1027	PB141	1290
30 KW 4 POLE	PB122	1027	PB142	1290
<b>125 X 100 - 200</b>	<b>PSFF2C</b>			
4 KW 4 POLE	PB049	812	PB050	883
5.5 KW 4 POLE	PB051	812	PB052	883
7.5 KW 4 POLE	PB178	812	PB053	883
30 KW 2 POLE	PB056	955	PB057	1071
37 KW 2 POLE	PB056	955	PB057	1071
45 KW 2 POLE	PB058	1113	PB059	1765
55 KW 2 POLE	PB179	1113	PB180	1852
75 KW 2 POLE	PB060	1438	PB061	1852

## ISO PUMP UNIT BASE KITS

### SOUTHERN CROSS ISO PUMP UNIT BASE KITS (Cont'd)

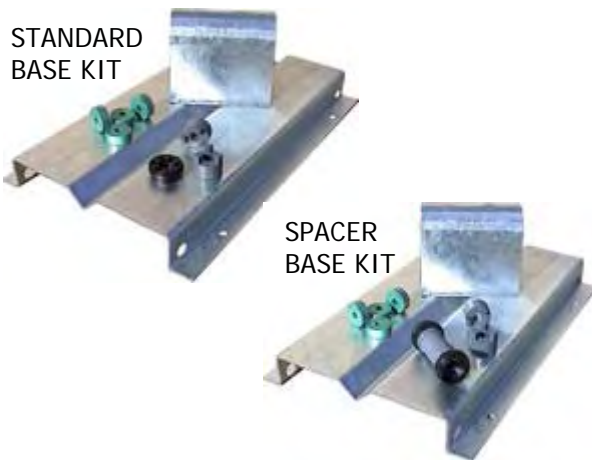

#### BASE KIT INCLUDES:-

- GALVANISED PRESSED STEEL BASEPLATE (NOT DRILLED)
- FLEXIBLE COUPLING
- GALVANISED COUPLING GUARD
- SHIMS FOR ON SITE ALIGNMENT
- SPACERS & FASTENERS FOR PUMP & MOTOR

#### NOTE:-

PRICES DO NOT INCLUDE ASSEMBLY OF UNITS. FOR COMPLETE UNITS REFER TO PES SECTION.

#### DISCOUNT CATEGORY A9

MODEL PUMP MOTOR	BASE KIT (INCLUDING COUPLING)			
	CODE	STANDARD PRICE \$	CODE	SPACER PRICE \$
<b>125 X 100 - 250</b>	<b>PSGF3C</b>			
7.5 KW 4 POLE	PB182	826	PB183	1027
11 KW 4 POLE	PB075	955	PB076	1071
15 KW 4 POLE	PB077	955	PB184	1071
55 KW 2 POLE	PB080	1101	PB081	1852
75 KW 2 POLE	PB185	1113	PB186	2440
90 KW 2 POLE	PB082	1737	PB083	2440
110 KW 2 POLE	PB187	2024	PB188	2440
<b>125 X 100 - 315</b>	<b>PSHF3C</b>			
11 KW 4 POLE	PB086	955	PB087	1071
15 KW 4 POLE	PB088	955	PB189	1071
18.5 KW 4 POLE	PB089	955	PB090	1071
22 KW 4 POLE	PB190	955	PB091	1071
90 KW 2 POLE	PB108	1949	PB109	2440
110 KW 2 POLE	PB193	1949	PB194	2440
132 KW 2 POLE	PB193	1949	PB194	2440
<b>125 X 100 - 400</b>	<b>PSJF3C</b>			
22 KW 4 POLE	PB195	983	PB114	1325
30 KW 4 POLE	PB115	983	PB116	1325
37 KW 4 POLE	PB123	1120	PB124	1584
45 KW 4 POLE	PB203	1120	PB204	1584
<b>150 X 125 - 250</b>	<b>PSGG3C</b>			
11 KW 4 POLE	PB086	955	PB087	1071
15 KW 4 POLE	PB088	955	PB189	1071
18.5 KW 4 POLE	PB089	955	PB090	1071
22 KW 4 POLE	PB190	955	PB091	1071
<b>150 X 125 - 315</b>	<b>PSHG3C</b>			
15 KW 4 POLE	PB198	983	PB201	1325
18.5 KW 4 POLE	PB112	983	PB113	1325
22 KW 4 POLE	PB195	983	PB114	1325
30 KW 4 POLE	PB115	983	PB116	1325
37 KW 4 POLE	PB117	1120	PB204	1584
45 KW 4 POLE	PB203	1120	PB204	1584
<b>150 X 125 - 400</b>	<b>PSJG3C</b>			
30 KW 4 POLE	PB149	983	PB150	1150
37 KW 4 POLE	PB125	1120	PB126	1584
45 KW 4 POLE	PB205	1120	PB206	1584
55 KW 4 POLE	PB207	2447	PB208	2627
75 KW 4 POLE	PB209	2827	PB210	4000

# ISO PUMP UNIT BASE KITS

## SOUTHERN CROSS ISO PUMP UNIT BASE KITS (Cont'd)



**BASE KIT INCLUDES:-**

GALVANISED FABRICATED STEEL BASE (DRILLED) TO ISO DIMENSIONS, GALVANISED COUPLING GUARD, FLEXIBLE COUPLING, SHIMS FOR ON SITE ALIGNMENT AND FASTENERS FOR PUMP & MOTOR

**NOTE:-**

PRICES DO NOT INCLUDE ASSEMBLY OF UNITS. FOR COMPLETE UNITS REFER TO PES SECTION.

**DISCOUNT CATEGORY A9**

MODEL PUMP MOTOR	BASE KIT (INCLUDING COUPLING)			
	STANDARD		SPACER	
	CODE	PRICE \$	CODE	PRICE \$
<b>125 X 100 - 500</b>	<b>PSKF4C</b>			
11 KW 6 POLE	PB301	2711	PB302	2837
15 KW 6 POLE	PB303	2711	PB304	2837
18.5 KW 6 POLE	PB305	2837	PB306	2973
22 KW 6 POLE	PB305	2837	PB306	2973
30 KW 6 POLE	PB307	2842	PB308	3734
45 KW 4 POLE	PB307	2842	PB308	3734
55 KW 4 POLE	PB309	3182	PB310	4156
75 KW 4 POLE	PB311	3195	PB312	4262
90 KW 4 POLE	PB313	3195	PB314	4262
<b>150 X 125 - 500</b>	<b>PSKG4C</b>			
18.5 KW 6 POLE	PB315	2723	PB316	2850
22 KW 6 POLE	PB315	2723	PB316	2850
30 KW 6 POLE	PB317	2842	PB318	3734
37 KW 6 POLE	PB319	3172	PB320	4156
55 KW 4 POLE	PB321	3172	PB322	4156
75 KW 4 POLE	PB323	3202	PB324	4191
90 KW 4 POLE	PB325	3202	PB326	4191
110 KW 4 POLE	PB327	3605	PB328	5059
132 KW 4 POLE	PB329	3605	PB330	5059
<b>200 X 150 - 315</b>	<b>PSHH4C</b>			
7.5 KW 6 POLE	PB331	2516	PB332	3056
11 KW 6 POLE	PB333	2516	PB334	3056
15 KW 6 POLE	PB335	2516	PB336	3056
30 KW 4 POLE	PB337	2559	PB338	3094
37 KW 4 POLE	PB339	2745	PB340	3128
45 KW 4 POLE	PB341	2745	PB342	3128
55 KW 4 POLE	PB343	2773	PB344	3229
<b>200 X 150 - 400</b>	<b>PSJH4C</b>			
15 KW 6 POLE	PB345	2516	PB346	3056
18.5 KW 6 POLE	PB347	2559	PB348	3094
22 KW 6 POLE	PB347	2559	PB348	3094
30 KW 6 POLE	PB349	2745	PB350	3128
55 KW 4 POLE	PB351	2773	PB352	3229
75 KW 4 POLE	PB353	2773	PB354	4091
90 KW 4 POLE	PB355	2773	PB356	4091
110 KW 4 POLE	PB357	3089	PB358	5059

## ISO PUMP UNIT BASE KITS

### SOUTHERN CROSS ISO PUMP UNIT BASE KITS (Cont'd)



#### BASE KIT INCLUDES:-

GALVANISED FABRICATED STEEL BASE (DRILLED) TO ISO DIMENSIONS, GALVANISED COUPLING GUARD, FLEXIBLE COUPLING, SHIMS FOR ON SITE ALIGNMENT AND FASTENERS FOR PUMP & MOTOR

#### NOTE:-

PRICES DO NOT INCLUDE ASSEMBLY OF UNITS. FOR COMPLETE UNITS REFER TO PES SECTION.

DISCOUNT CATEGORY A9

MODEL PUMP MOTOR	BASE KIT (INCLUDING COUPLING)			
	STANDARD		SPACER	
	CODE	PRICE \$	CODE	PRICE \$
<b>200 X 150 - 500</b>	<b>PSKH4C</b>			
22 KW 6 POLE	PB359	2559	PB360	3094
30 KW 6 POLE	PB361	2745	PB362	3734
37 KW 6 POLE	PB363	2773	PB364	3734
45 KW 6 POLE	PB365	2773	PB366	4091
55 KW 6 POLE	PB367	2773	PB368	4091
75 KW 4 POLE	PB365	2773	PB366	4091
90 KW 4 POLE	PB367	2773	PB368	4091
110 KW 4 POLE	PB369	3089	PB370	4830
132 KW 4 POLE	PB371	3089	PB372	5059
160 KW 4 POLE	PB373	3089	PB374	5059
200 KW 4 POLE	PB373	3089	PB374	5059
<b>250 X 200 - 315</b>	<b>PSHJ4C</b>			
11 KW 6 POLE	PB375	2516	PB376	3056
15 KW 6 POLE	PB377	2516	PB378	3056
18.5 KW 6 POLE	PB379	2559	PB380	3094
22 KW 6 POLE	PB379	2559	PB380	3094
37 KW 4 POLE	PB381	2745	PB382	3128
45 KW 4 POLE	PB383	2745	PB384	3128
55 KW 4 POLE	PB385	2773	PB386	3229
75 KW 4 POLE	PB387	3273	PB388	4091

## PUMP EXPANSION COUPLINGS

TABLE 'E' E.P.D.M. SINGLE-SPHERE CONNECTORS WITH ZINC PLATED FLANGES

- Prevent stresses due to extension and contraction
- Insulate against the transfer of noise and vibration
- Compensate for misalignment
- Alternative flange connections & rubber compounds available



Nominal Diameter		Installed Length mm		Travel mm	Pressures		CODE	PRICE \$
mm	inch	Natural Length "F"	Minimum Maximum Installed	Total Compressed Extended	Positive MPa	Vacuum mm		
50	2"	105	99-107	99-110	1.55	660	EXP050	92
65	2½"	115	107-118	103-121	1.55	660	EXP065	94
80	3"	130	122-133	118-133	1.55	660	EXP080	115
100	4"	135	122-140	117-145	1.55	660	EXP100	141
125	5"	170	156-175	152-180	1.55	660	EXP125	205
150	6"	180	167-185	162-190	1.55	660	EXP150	251
200	8"	205	186-212	180-220	1.55	660	EXP200	381
250	10"	240	221-247	215-254	1.55	660	EXP250	537
300	12"	260	241-267	235-274	1.55	660	EXP300	702

**PUMP ACCESSORIES**

**GALVANISED PRESSED STEEL PUMP BASE PLATES**

Bases are for up to 132kW units only.

Prices do not include drilling for motor and pump or fasteners and spacers for mounting unit on baseplate

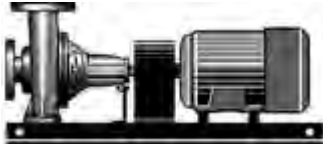
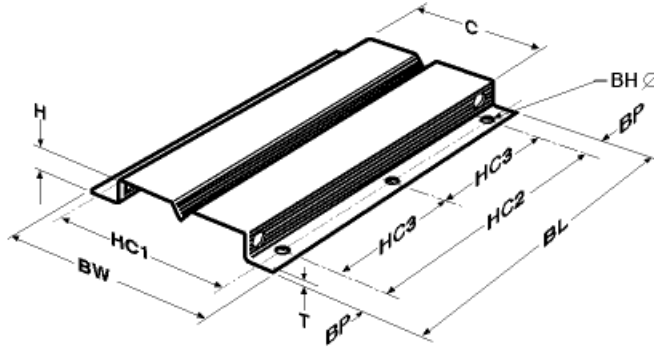

**BASES FOR LONG COUPLED PUMP UNITS**

**DISCOUNT CATEGORY A9**

DIMENSIONS IN mm										MASS	CODE	PRICE \$
BL	BW	C	BH $\varnothing$	HC1	HC2	HC3	BP	H	T	kg		
1100	426	366	15	396	900	450	100	40	5	23.0	SEA613	297
1200	520	410	15	470	900	450	150	74	5	32.2	SEA623	425
1200	572	462	19	522	900	450	150	93	6	44.4	SEA632	575
1500	622	512	19	572	1200	600	150	68	6	54.7	SEA634	477
1500	676	576	24	626	1100	550	200	120	8	88.5	SEA642	1063
1500	676	576	24	626	1100	550	200	120	10	110.6	SEA711	1179
1500	676	576	24	626	1100	550	200	120	12	133.0	SEA721	1781
1600	731	631	24	681	1200	600	200	120	8	100.5	SEA643	1365
1600	731	631	24	681	1200	600	200	120	10	126.0	SEA712	1523
1600	731	631	24	681	1200	600	200	120	12	150.7	SEA722	1683
1800	775	675	24	725	1400	700	200	120	12	178.0	SEA723	1872

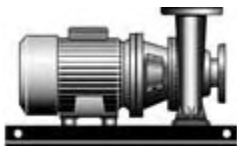

**BASES FOR MOTORPUMPS**

600	426	366	15	396	400	-	100	40	5	13.0	SED610	173
750	520	410	15	470	450	-	150	74	5	20.0	SED612	358
900	572	462	19	522	600	-	150	93	6	33.0	SED614	417
1100	622	512	19	572	800	-	150	68	6	40.1	SED616	494
1200	676	576	24	626	800	-	200	120	8	71.0	SED618	1027
1500	775	675	24	725	1100	550	200	120	12	189.0	SED619	1378

**SOUTHERN CROSS HAND OPERATED PRIMING PUMP**

**HAND OPERATED DIAPHRAGM PUMP**



MODEL	CODE	PRICE \$
KDC 25 X 20	PM900	472

Pump suitable for Hand Priming of Pump Suction Lines.  
 Pump Suction Connection screwed 25NB (1" BSP) Female Bottom Entry.  
 Pump Discharge Connection screwed 20NB (3/4" BSP) Female Side Discharge.  
 Capacity: 0.5 litres per second against discharge heads up to 12m and with suction lift not exceeding 7.5m

## PUMP ACCESSORIES

### FLEXIBLE SHAFT COUPLINGS - Selection Procedure

- (A) **SERVICE FACTOR** Determine appropriate SERVICE FACTOR from table below.
  - (B) **DESIGN POWER** Multiply running power of driven machine by the service factor. This gives DESIGN POWER which is used as a basis for coupling selection.
  - (C) **COUPLING SIZE** Refer to table for your required coupling type and read from the appropriate speed column until a power equal to or greater than the DESIGN POWER is found.
  - (D) **BORE SIZE** Refer to coupling dimensional data table to check that the required bores can be accommodated.
- EXAMPLE** – A coupling is required to transmit 30kW from an electric motor running at 1450 RPM driving a centrifugal pump for 12 hours per day. The motor shaft diameter is 55mm and the pump shaft diameter is 42mm.
- (A) **SERVICE FACTOR** From table the service factor is 1.0
  - (B) **DESIGN POWER** design power is 30 x 1.0 = 30kW
  - (C) **COUPLING SIZE** Reading from 1500 RPM speed column 30.15kW is the first power to exceed the DESIGN POWER of 30kW. The size of the coupling specified in the first column is SW190.
  - (D) **BORE SIZE** Dimensional data table shows that both shaft diameters are within the range available.

FLEXIBLE COUPLING SERVICE FACTORS SPECIAL CLASSES For applications where substantial shock, vibration and torque fluctuations occur and for reciprocating machines e.g. internal combustion engines, piston pumps and compressors, refer to Southern Cross with full unit details.	Type of Driving Unit					
	Electric Motors			Internal Combustion Engines Water Turbines		
	Hours per Day Duty			Hours per Day Duty		
Driven Machine Class	8	8-16	Over 16	8	8-16	Over 16
<b>Uniform</b> Centrifugal Pumps and Fans, Agitators, Centrifugal Blowers, Conveyors, Generators, Evaporators and Feeders.	SERVICE FACTOR			SERVICE FACTOR		
<b>Moderate Shock*</b> Non-uniformly Loaded Centrifugal Pumps, Gear Pumps, Bucket Elevators, Centrifugal Compressors, Rotary Screens, Clay Working Machinery and Crane Hoists.	1.00	1.00	1.00	1.00	1.00	1.00
<b>Heavy Shock*</b> Centrifugal Pumps - Frequently Starting, Reciprocating Pumps, Cooling Towers fans, Crushers, Shakers, Welding Sets, Hammer Mills and Vibrating Screens.	1.10	1.10	1.20	1.20	1.25	1.25
	1.25	1.40	1.60	1.60	1.80	2.00

\* It is recommended that keys with top clearance are fitted for applications where load fluctuation is expected.

### FLEXIBLE SHAFT COUPLINGS DIMENSION DATA

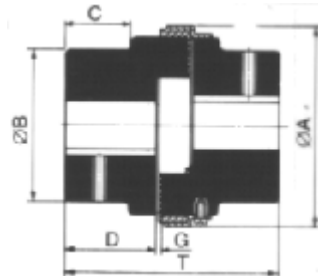

"SW"  
STANDARD  
COUPLING

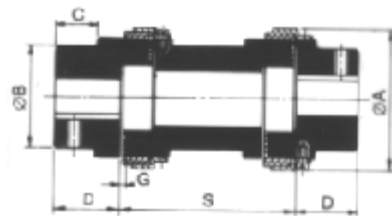

"RRS"  
SPACER  
COUPLING

S = Spacer Length 100,140 or 180mm

Coupling Model	Rated Torque Nm	kW Capacity			Bore		øA	Length Thru Bore D	øB	Gap G	C	Overall Length T (SW)
		100 RPM	1500 RPM	3000 RPM	Min.	Max.						
095	21.1	0.22	3.30	6.60	10	28	65	25	49	2	13	63
100	46.4	0.49	7.35	14.70	10	35	78	35	57	2	22	88
110	89.0	0.93	13.95	27.90	15	42	96	43	76	3	30	108
150	141	1.49	22.35	44.70	15	48	111	45	80	3	30	115
190	190	2.01	30.15	60.30	20	55	129	54	102	3	35	133
225	265	2.76	41.40	82.80	20	60	142	64	108	3	45	153
226	317	3.43	51.45	102.90	25	65	153	70	115	3	54	178
The following sizes are standard SW Couplings only - spacer type available P.O.A.												
276	527	5.60	84.00	168.00	25	75	173	80	127	3	61	200
280	782	8.20	123.00	246.00*	30	75	208	80	140	3	61	200
295	1279	13.40	201.00	-	30	90	253	95	160	3	70	238

\*Dynamic balancing required at this speed. Materials of construction: Drive and driven flanges - Cast Iron; Spacer - Aluminium

**PUMP ACCESSORIES**

**FLEXIBLE SHAFT COUPLINGS**



Note - When ordering, 3 codes are required. 1: Code for Coupling Element. 2: Code for Drive Half. 3: Code for Driven Half

**QUICK PRICE REFERENCE - COMPLETE COUPLINGS**

**DISCOUNT CATEGORY A9**

COUPLING SIZE	PRICE - COMPLETE COUPLING BORED AND KEVED TO SIZES LISTED BELOW			
	STANDARD COUPLING	SPACER TYPE COUPLING W/- 100mm SPACER	SPACER TYPE COUPLING W/- 140mm SPACER	SPACER TYPE COUPLING W/- 180mm SPACER
	PRICE \$	PRICE \$	PRICE \$	PRICE \$
095	62	206	208	252
100	95	270	270	327
110	129	344	355	415
150	157	421	421	536
190	231	558	558	695
225	270	718	718	861
226	310	787	787	944
276	378	P.O.A.	P.O.A.	P.O.A.
280	557	P.O.A.	P.O.A.	P.O.A.
295	701	P.O.A.	P.O.A.	P.O.A.

**STD COUPLING ELEMENT**



**SPACER COUPLING ELEMENTS SPACER**

COUPLING SIZE	STANDARD COUPLING ELEMENT		SPACER COUPLING ELEMENT AND SPACER					
	CODE	PRICE \$	100mm SPACER		140 mm SPACER		180mm SPACER	
			CODE	PRICE \$	CODE	PRICE \$	CODE	PRICE \$
095	XRC014	29	SXC095R	152	SXC095S	154	SXC095T	200
100	XRC015	38	SXC100R	185	SXC100S	185	SXC100T	245
110	XRC016	39	SXC110R	228	SXC110S	239	SXC110T	302
150	XRC017	48	SXC150R	278	SXC150S	278	SXC150T	400
190	XRC018	62	SXC190R	345	SXC190S	345	SXC190T	490
225	XRC019	74	SXC225R	473	SXC225S	473	SXC225T	623
226	XRC020	85	SXC226R	504	SXC226S	504	SXC226T	669
276	XRC021	89	-	P.O.A.	-	P.O.A.	-	P.O.A.
280	XRC022	105	-	P.O.A.	-	P.O.A.	-	P.O.A.
295	XRC023	148	-	P.O.A.	-	P.O.A.	-	P.O.A.

**COUPLING HALVES (STD & SPACER)**

BORE SIZE	COUPLING SIZE									
	95	100	110	150	190	225	226	276	280	295
Pilot Bore	XRC001A	XRC002A	XRC003A	XRC004A	XRC005A	XRC006A	XRC007A	XRC008A	XRC009A	XRC010A
14mm	XRC001B	-	-	-	-	-	-	-	-	-
19mm	XRC001C	-	XRC003C	-	-	-	-	-	-	-
24mm	XRC001D	XRC002D	XRC003D	XRC004D	XRC005D	-	-	-	-	-
28mm	XRC001E	XRC002E	XRC003E	-	-	-	-	XRC008E	-	-
32mm	-	XRC002F	XRC003F	XRC004F	XRC005F	XRC006F	XRC007F	XRC008F	XRC009F	XRC010F
38mm	-	-	XRC003G	-	-	-	-	XRC008G	XRC009G	XRC010G
42mm	-	-	XRC003H	XRC004H	XRC005H	XRC006H	XRC007H	XRC008H	XRC009H	XRC010H
48mm	-	-	-	XRC004J	XRC005J	XRC006J	XRC007J	XRC008J	XRC009J	XRC010J
55mm	-	-	-	-	XRC005K	XRC006K	XRC007K	XRC008K	XRC009K	XRC010K
60mm	-	-	-	-	-	XRC006L	XRC007L	XRC008L	XRC009L	XRC010L
65mm	-	-	-	-	-	-	XRC007M	XRC008M	XRC009M	XRC010M
70mm			-	-	-	-	-	XRC008N	XRC009N	XRC010N
75mm	-	-	-	-	-	-	-	XRC008P	XRC009P	XRC010P
80mm	-	-	-	-	-	-	-	-	-	XRC010Q
85mm	-	-	-	-	-	-	-	-	-	XRC010R
90mm	-	-	-	-	-	-	-	-	-	XRC010S
COUPLING HALF	PRICE \$	PRICE \$	PRICE \$	PRICE \$	PRICE \$	PRICE \$	PRICE \$	PRICE \$	PRICE \$	PRICE \$
	18	31	48	59	91	106	121	155	242	296

**EXAMPLE OF ORDERING (3 CODES REQUIRED)**

Coupling Element Code XRC014  
 Drive Half (14mm bore) XRC001B  
 Driven Half Code (28mm Bore) XRC001E

## PUMP ACCESSORIES

**ELECTRIC MOTORS  
2 YEAR WARRANTY**

**DISCOUNT CATEGORY A9**

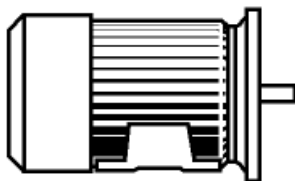
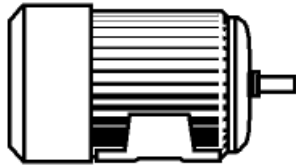

**2 YEAR WARRANTY  
CAST IRON FRAME  
CLASS "F" INSULATION  
IP55 ENCLOSURE  
A.S. CONDUIT THREADS  
SKF C3 BEARINGS TO 180  
FRAME  
NSK CM BEARINGS ABOVE  
180 FRAME  
MEPS TABLE B2**

3 X 415V THREE PHASE 2 POLE							
kW	FRAME	B3 FOOT MOUNT		B3/B5 FOOT & FLANGE MOUNT		CURRENT	
		CODE	PRICE \$	CODE	PRICE \$	FULL LOAD(A)	LOCKED ROTOR(%)
0.75	801-2	XZM082	201	XZM002	189	1.56	680
1.10	802-2	XZM083	283	XZM003	293	2.25	720
1.50	90S-2	XZM084	289	XZM004	307	2.92	750
2.20	90L-2	XZM085	344	XZM005	367	4.20	760
3.00	100L-2	XZM086	361	XZM006	407	5.53	810
4.00	112M1-2	XZM087	465	XZM007	479	7.22	830
5.50	132S1-2	XZM088	619	XZM008	635	9.80	830
7.50	132S2-2	XZM089	717	XZM009	730	13.20	770
11.00	160M1-2	XZM090	1077	XZM011	1203	19.00	750
15.00	160M2-2	XZM091	1234	XZM012	1358	25.60	750
18.50	160L-2	XZM092	1417	XZM013	1581	31.50	750
22.00	180M-2	XZM093	1933	XZM014	2001	36.90	750
30.00	200L1-2	XZM094	2337	XZM015	2551	49.90	750
37.00	200L2-2	XZM095	3173	XZM016	3194	61.30	750
45.00	225M-2	XZM096	3603	XZM017	3877	74.20	750
55.00	250M1-2	XZM097	4375	XZM018	4714	90.40	750
75.00	280S-2	XZM098	5302	XZM019	5672	122.00	750
90.00	280M1-2	XZM099	6565	XZM020	6932	146.00	750
110.00	315M2-2	XZM100	8584	XZM021	8946	175.00	710
132.00	315M-2	XZM101	12197	XZM022	12688	211.00	710
160.00	315L1-2	XZM102	12812	XZM023	13709	259.00	710
3 X 415V THREE PHASE 4 POLE							
0.55	801-4	XZM106	239	XZM041	239	1.26	650
0.75	802-4	XZM107	254	XZM042	253	1.70	660
1.10	90S-4	XZM108	258	XZM043	284	2.37	680
1.50	90L-4	XZM109	276	XZM044	293	3.19	700
2.20	100L1-4	XZM110	338	XZM045	361	4.38	740
3.00	100L2-4	XZM111	404	XZM046	449	5.90	740
4.00	112M-4	XZM112	482	XZM047	541	7.68	750
5.50	132S-4	XZM113	632	XZM048	660	10.30	780
7.50	132M1-4	XZM114	759	XZM049	826	13.80	740
11.00	160M-4	XZM115	1148	XZM051	1203	19.80	700
15.00	160L-4	XZM116	1286	XZM052	1449	26.70	700
18.50	180M-4	XZM117	1615	XZM053	1817	32.50	750
22.00	180L-4	XZM118	1990	XZM054	2191	38.50	780
30.00	200L-4	XZM119	2452	XZM055	2205	52.10	720
37.00	225S-4	XZM120	3387	XZM056	2993	63.20	740
45.00	225M-4	XZM121	3672	XZM057	3946	76.60	740
55.00	250M1-4	XZM122	4508	XZM058	4845	93.40	740
75.00	250M2-4	XZM123	5702	XZM059	5913	125.00	740
90.00	280M1-4	XZM124	6303	XZM060	7174	151.00	720
110.00	280M2-4	XZM125	9207	XZM061	9187	182.00	720
132.00	315M-4	XZM126	10872	XZM062	11599	216.00	690
160.00	315L1-4	XZM127	16297	XZM063	17144	259.00	690
200.00	315L2-4	XZM128	16362	XZM064	17265	328.00	690
3 X 415V THREE PHASE 6 POLE							
11.00	160L-6	XZM321	1447	XZM351	1571	21.60	690
15.00	180L-6	XZM322	1804	XZM352	2086	28.40	720
18.50	200L1-6	XZM323	2235	XZM353	2539	34.80	720
22.00	200L2-6	XZM324	2382	XZM354	2683	40.20	750
30.00	225M-6	XZM325	3672	XZM355	4055	53.70	710
37.00	250M-6	XZM326	4669	XZM356	5160	65.20	700
45.00	280S-6	XZM327	5906	XZM357	6439	78.10	700
55.00	280M1-6	XZM328	6378	XZM358	6893	94.10	700
75.00	225M-6	XZM329	11184	XZM359	11911	130.00	700
90.00	250M-6	XZM330	11648	XZM360	12375	153.00	700
110.00	280S-6	XZM331	14475	XZM361	14151	187.00	670
132.00	280M1-6	XZM332	15186	XZM362	15913	222.00	670
150.00	280S-6	XZM333	17902	XZM363	18604	269.00	670

**PUMP ACCESSORIES**

**ELECTRIC MOTORS - HIGH EFFECIENCY  
2 YEAR WARRANTY**

**DISCOUNT CATEGORY A9**

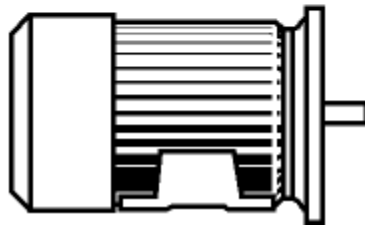
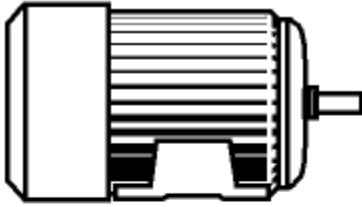

3 X 415V THREE PHASE 2 POLE							
KW	FRAME	B3 FOOT MOUNT		B3/B5 FOOT & FLANGE MOUNT		CURRENT	
		CODE	PRICE \$	CODE	PRICE \$	FULL LOAD(A)	LOCKED ROTOR(%)
3.0	D100	XZM586-HE	651	XZM506-HE	684	5.36	932
4.0	D112	XZM587-HE	732	XZM507-HE	769	7.01	856
5.5	D132	XZM588-HE	895	XZM508-HE	939	9.67	776
7.5	D132	XZM589-HE	1052	XZM509-HE	1107	14.30	629
11.0	D160	XZM590-HE	1647	XZM511-HE	1732	18.40	761
15.0	D160	XZM591-HE	2029	XZM512-HE	2129	24.70	789
18.5	D160	XZM592-HE	2706	XZM513-HE	2893	30.50	803
22.0	D180	XZM593-HE	3426	XZM514-HE	3736	38.10	787
30.0	D200	XZM594-HE	4200	XZM515-HE	4636	49.60	685
37.0	D200	XZM595-HE	5110	XZM516-HE	5551	61.00	656
45.0	D225	XZM596-HE	6571	XZM517-HE	7206	72.00	736
55.0	D250	XZM597-HE	8529	XZM518-HE	9431	91.50	705
75.0	D280	XZM598-HE	10732	XZM519-HE	11644	119.00	693
90.0	D280	XZM599-HE	13984	XZM520-HE	15256	148.10	739
110.0	D280M	XZM600-HE	14219	XZM521-HE	15493	179.10	731
132.0	D315	XZM601-HE	19156	XZM522-HE	20795	213.50	721
150.0	D315	XZM602-HE	22627	XZM523-HE	24283	241.30	725
3 X 415V THREE PHASE 4 POLE							
1.1	D90	XZM608-HE	456	XZM543-HE	630	2.21	905
1.5	D90	XZM609-HE	504	XZM544-HE	529	3.10	968
2.2	D100	XZM610-HE	602	XZM545-HE	633	4.24	973
3.0	D100	XZM611-HE	669	XZM546-HE	702	5.95	924
4.0	D112	XZM612-HE	836	XZM547-HE	877	7.69	845
5.5	D132	XZM613-HE	895	XZM548-HE	1107	10.10	891
7.5	D132	XZM614-HE	1340	XZM549-HE	1405	13.60	882
11.0	D160	XZM615-HE	1960	XZM551-HE	2058	19.80	707
15.0	D160	XZM616-HE	2375	XZM552-HE	2489	25.40	728
18.5	D180	XZM617-HE	3130	XZM553-HE	3437	32.50	754
22.0	D180	XZM618-HE	3580	XZM554-HE	3888	38.50	701
30.0	D200	XZM619-HE	4258	XZM555-HE	4695	50.50	773
37.0	D225S	XZM620-HE	5339	XZM556-HE	5972	64.30	669
45.0	D225	XZM621-HE	6707	XZM557-HE	7346	77.10	642
55.0	D250	XZM622-HE	7137	XZM558-HE	8033	93.70	700
75.0	D280	XZM623-HE	10294	XZM559-HE	11203	125.00	648
90.0	D280	XZM624-HE	12641	XZM560-HE	13907	151.30	734
110.0	D315	XZM625-HE	13946	XZM561-HE	P.O.A.	182.20	719
132.0	D315	XZM626-HE	17764	XZM562-HE	P.O.A.	217.10	709
150.0	D315	XZM627-HE	19810	XZM563-HE	P.O.A.	246.20	711
185.0	D315	XZM628-HE	24676	XZM564-HE	P.O.A.	302.00	725
3 X 415V THREE PHASE 6 POLE							
11.0	D160	XZM721-HE	2489	XZM751-HE	P.O.A.	22.10	724
15.0	D180	XZM722-HE	3326	XZM752-HE	P.O.A.	26.90	613
18.5	D200	XZM723-HE	3832	XZM753-HE	P.O.A.	35.80	615
22.0	D200	XZM724-HE	4722	XZM754-HE	P.O.A.	42.20	592
30.0	D225	XZM725-HE	6753	XZM755-HE	P.O.A.	51.70	590
37.0	D250	XZM726-HE	7854	XZM756-HE	P.O.A.	63.80	634
45.0	D250	XZM727-HE	10556	XZM757-HE	P.O.A.	76.20	767
55.0	D280	XZM728-HE	12466	XZM758-HE	P.O.A.	96.00	677

**2 YEAR WARRANTY  
CAST IRON FRAME  
CLASS "F" INSULATION  
IP55 ENCLOSURE  
A.S. CONDUIT THREADS  
SKF C3 BEARINGS TO 180  
FRAME  
NSK CM BEARINGS ABOVE  
180 FRAME  
MEPS TABLE B3**